



Vertiv™ Liebert® GXT5 Lithium-Ion UPS

1000 - 3000VA 230V

Rack/Tower

Intelligent and Efficient Double
Conversion Online UPS Offers the
Highest Level of Power Protection



The Vertiv™ Liebert GXT5 Lithium-Ion UPS provides the highest level of power protection for your business critical IT applications.

High Performance Online Power Protection

The GXT5 Lithium-Ion double conversion online UPS provides both the highest level of power conditioning and battery backup for business critical IT equipment such as business network gear and servers ensuring your mission-critical applications are protected in the event of an unanticipated loss of power or an unprecedented power surge.

The GXT5 Lithium-Ion UPS protects against the widest range of power fluctuations and automatically switches to battery backup when power loss is detected. With a 0.9 or better output power factor (PF) and no transfer time to operation on battery, you can ensure your most critical assets are protected.

Protects Against

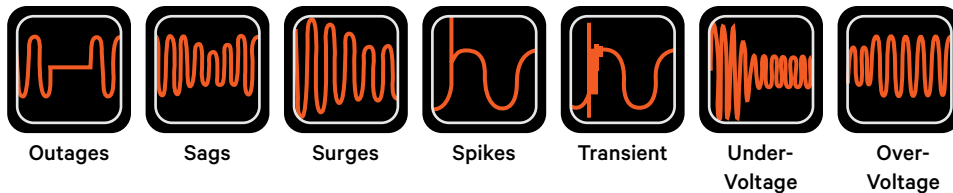

The rack/tower convertible design of the Vertiv Liebert GXT5 Lithium-Ion UPS makes it ideal for edge or distributed IT applications where floor space is at a premium. It is a true low-maintenance, set-it and forget-it solution ideal for remote locations with limited onsite technical resources.

Vertiv Liebert GXT5 Lithium-Ion Overview

- 1000VA, 1500VA, 2000VA, & 3000VA UPSs in a rack/tower convertible form factor
- Standard 5-year warranty provides peace of mind that your investment is protected against potentially costly equipment failures
- Achieve the lowest total cost of ownership over the lifetime of the UPS with fewer battery replacements and up to 10 years of useable life
- Hot-swappable, user-replaceable batteries increase the useable life of the UPS by allowing you to easily replace the batteries without disrupting power to connected equipment
- Internal batteries offer industry-leading runtime (up to 14 minutes at full load) to protect critical equipment during an unexpected power loss
- Lithium-Ion battery technology offers better performance in high temperature environments, supports up to 10 times more discharge cycles, and delivers faster recharge times compared to VRLA batteries

Why should you choose Lithium-Ion Technology?

LONGER LIFE

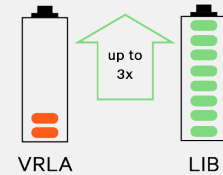

LOWEST TCO



SMALLER AND LIGHTER

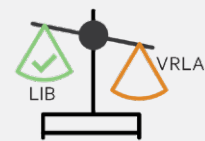

LONGER RUNTIME



ENVIRONMENTALLY FRIENDLY



FAST BATTERY RECHARGE



Lithium-Ion technology delivers up to 3 times the life expectancy of lead-acid batteries and lowers the total cost of ownership by nearly half

Lithium-Ion Outperforms VRLA when compared...

Battery Feature	VRLA Battery	Lithium-Ion Battery	Lithium-Ion Benefit
Standard battery life	3-5 years	8-10 years	Up to 3 times longer life
Typical cycle life	200-260	2000	Up to 10x more discharge/recharge cycles
Battery recharge time (@ 90%)	3-6 hours	<2 hours	Fast recovery time safeguards your critical IT equipment in the event of multiple outages
Battery weight	10.9 kg	5.9 kg	45% lighter making it ideal for small spaces and wall-mount racks
Warranty	2 or 3 years	5 years	Worry free operation so you can set-it and forget-it

Visit the TCO calculator at vertiv.com -> Products & Services -> UPS -> GXT5 Lithium -> Models to calculate the cost savings for your installation.

Build Your Total Infrastructure Solution with Vertiv

Discover expert designed IT infrastructure solutions with proven success in diverse environments and countless applications.

Vertiv™ VR Rack
Self-contained 42U server rack designed to simplify equipment installation and provides an additional 6cm of useable depth.

Vertiv™ Geist™ rPDU
Reliable power distribution with outlet level remote monitoring and management providing the highest level of power visibility and control.

Cable and Air Flow Management
Included accessories ensure proper cable management and airflow to keep your equipment cool.

Software and IT Management
Monitor the entire system either locally or remotely to ensure you are alerted of out-of-range conditions that could result in costly downtime.

Vertiv™ VRC
Keep critical IT equipment cool with a dedicated high-efficiency rack-mount cooling system with scalable capacity.

Vertiv™ Liebert GXT5 Lithium-Ion UPS
Protect mission critical equipment in the event of power loss or extreme power fluctuations.

Visit Vertiv.com or contact a Vertiv Sales Representative today to find out how Vertiv can help you configure an all-in-one infrastructure solution.

High Performance



0.9 (or Better) Output Power Factor (PF): Provides more useable power enabling you to connect more equipment saving you money and space.



Increased Runtime: Internal batteries offer up to 14 minutes of runtime at full load.

Programmable Outlet Group: Extend run time when on battery power by power-cycling connected equipment and shedding less critical loads.



Battery Backed Outlets: Up to 7 battery backed outlets ensuring critical equipment is protected.

Advanced Warning Status: Receive early audible and visual alarms warning you of system status to alert you to an input voltage, output overload, low battery, or battery replacement condition.

Wide Input Voltage Range: Prolong battery life by allowing the UPS to maximize the use of the utility power before transferring to battery.

Superior Battery Technology

Fewer Battery Replacements: Lithium-Ion batteries require fewer battery replacements and last on average up to 3 times as long as traditional VRLA batteries reducing maintenance, labor, and replacement costs (lower TCO).

More Discharge Cycles: Lithium-Ion batteries deliver up to 10 times more charge / discharge cycles than VRLA batteries.

Fast Recharge: Lithium-Ion batteries recharge twice as fast as traditional VRLA batteries getting you back to 90% in as little as 2 hours.

Hot-Swappable, User-Replaceable Batteries: Increase product life and reliability with batteries that can be easily replaced without disrupting power to connected equipment.

Safe and Reliable: Safest Lithium-Ion (LiFePO4) battery chemistry and integrated battery management system (BMS) ensure safe and reliable operation.

Environmentally Friendly: Significantly reduce battery disposal and recycling with lower replacement rates.

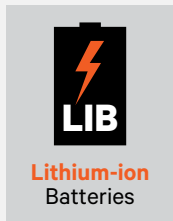

Enhanced Manageability

LCD Display: User-friendly full-color LCD interface with gravity sensing orientation simplified installation and configuration while also providing instant at-a-glance status and insights.

Free Power Management Software:

- Vertiv™ [Power Insight](#) – Add the Liebert® RDU101 card for web/SNMP manageability
- Vertiv™ [Power Assist](#) – Monitor UPS conditions through a local USB connection
- Vertiv™ Intelligence Director – Together with Vertiv™ Geist™ rPDU one single IP Address to monitor and manage up to 50 devices



Remote Monitoring and Management: Add an optional Liebert® IntelliSlot RDU101 communication card to enable remote monitoring / management (web based, SNMP, BACnet, MODBUS and relay contacts) and environmental monitoring via external sensors.

Remote Emergency Power Off: Remotely shutdown the UPS during an emergency.



Vertiv™ Liebert® GXT5 Lithium-Ion Features



High power factor (0.9-1.0)
More usable power enables more connected loads saving space and costs.



Efficiency (up to 95%) in online mode
Higher efficiency means an optimized energy management and lower heat dissipation, for energy savings and improved reliability.



Efficiency (up to 98%) in Active ECO mode
Superior protection with maximum efficiency.



Colored graphic LCD with gravity sensitive orientation
User-friendly interface provides insight to UPS status for easy installation, configuration and operation.

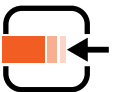

Compact rack/tower design
Space-saving UPS provides rack space optimization and flexible installation.



Battery cabinets with auto-detection
Be confident the UPS is set up correctly to report available runtime when used with external battery cabinets.



Product warranty
Comprehensive coverage through a standard five-year advanced exchange warranty.

Vertiv™ Liebert GXT5 Lithium-Ion UPS | 1000 - 3000VA 230V UPS

1000-1500VA – 230V Rack/Tower

External Battery Connector

Scalable runtime solution supported for extended outage protection (up to 8 EBs)

2 x Controllable Outlet Groups

Manage load on battery and control unauthorized access to UPS receptacle



Communications

IntelliSlot (Web/SNMP Card), Serial Port, Dry Contacts, USB Port for Local and Remote Configuration and UPS Management

IEC C14 input with over current protection

Simple installation and power on with connected input cord

2000VA – 230V Rack/Tower

External Battery Connector

Scalable runtime solution supported for extended outage protection (up to 8 EBCs)

2x Controllable Outlet Groups, 2x Always on Receptacles

Manage loads on battery and control unauthorized access to UPS receptacles



Communications

SNMP, Serial, Dry contact, Local USB
Local and remote configuration and UPS Management

IEC C20 input with over current protection

3000VA – 230V Rack/Tower

External Battery Connector

Scalable runtime solution supported for extended outage protection (up to 8 EBCs)

IEC C19 Outlet

Support larger devices or rack PDU

2x Controllable Outlet Groups, 2x Always on Receptacles

Manage loads on battery and control unauthorized access to UPS receptacles



Communications

SNMP, Serial, Dry contact, Local USB
Local and remote configuration and UPS Management

IEC C20 input with over current protection

Simple installation and power up

Technical Specifications | 1000 VA - 3000 VA, 230V, Rack/Tower Convertible

Standard Models*	GXT5LI-1000IRT2UXL	GXT5LI-1500IRT2UXL	GXT5LI-2000IRT2UXL	GXT5LI-3000IRT2UXL
Form Factor	2U Rack/Tower	2U Rack/Tower	2U Rack/Tower	2U Rack/Tower
Power Rating	1000VA / 1000W	1500VA / 1500W	2000VA / 2000W	3000VA / 2700W
Dimensions, W x D x H, MM (IN)				
Unit	430 x 446 x 85 (16.9 x 17.3 x 3.4)	430 x 476 x 85 (16.9 x 18.7 x 3.4)	430 x 476 x 85 (16.9 x 18.7 x 3.4)	430 x 546 x 85 (16.9 x 21.5 x 3.4)
Shipping	570 x 597 x 242 (22.4 x 23.5 x 9.5)	570 x 597 x 242 (22.4 x 23.5 x 9.5)	570 x 597 x 242 (22.4 x 23.5 x 9.5)	570 x 717 x 242 (22.4 x 28.2 x 9.5)
Weight, KG (LB)				
Unit	16kg	17kg	17kg	21kg
Shipping	21kg	24kg	24kg	27kg
Input/Output AC Parameters				
Input	IEC C14	IEC C14	IEC C20	IEC C20
Total Receptacles	(8) IEC C13	(8) IEC C13	(8) IEC C13	(1) IEC C19 (6) IEC C13
Programmable Receptacles	(2) Groups of (3) IEC C13	(2) Groups of (3) IEC C13	(2) Groups of (3) IEC C13	(2) Groups of (3) IEC C13
Nominal Voltage Setting	230VAC Default; 200/208/220/230/240VAC (User-Configurable)	230VAC Default; 200/208/220/230/240VAC (User-Configurable)	230VAC Default; 200/208/220/230/240VAC (User-Configurable)	230VAC Default; 200/208/220/230/240VAC (User-Configurable)
Voltage Range Without Battery Operation	Nominal (Full Load): 176 - 288 VAC; Maximum: 115 - 288 VAC	Nominal (Full Load): 176 - 288 VAC; Maximum: 115 - 288 VAC	Nominal (Full Load): 176 - 288 VAC; Maximum: 115 - 288 VAC	Nominal (Full Load): 176 - 288 VAC; Maximum: 115 - 288 VAC
Frequency Range	40-70Hz	40-70Hz	40-70Hz	40-70Hz
Surge Protection	EC 61000-4-5, ANSI C62.41, Category B	EC 61000-4-5, ANSI C62.41, Category B	EC 61000-4-5, ANSI C62.41, Category B	EC 61000-4-5, ANSI C62.41, Category B
Transfer Time	0 ms	0 ms	0 ms	0 ms
Battery Waveform	Pure Sine Wave	Pure Sine Wave	Pure Sine Wave	Pure Sine Wave
Battery Parameters				
Type	Lithium-Ion (LiFePO4)	Lithium-Ion (LiFePO4)	Lithium-Ion (LiFePO4)	Lithium-Ion (LiFePO4)
Recharge Time (from full discharge)	< 2 hrs to 90%	< 2 hrs to 90%	< 2 hrs to 90%	< 2 hrs to 90%
Full-Load Runtime	12 min	13 min	9 min	6.5 min
Half-Load Runtime	26.5 min	27 min	21 min	14.5 min
External Battery Cabinet	VEBCLI-48VRT1U	VEBCLI-48VRT1U	VEBCLI-48VRT1U	VEBCLI-48VRT1U
Environmental				
Operating Temperature, °C (°F)	0°C to 40°C (32°F to 104°F) (10% Derating at 50°C)	0°C to 40°C (32°F to 104°F) (10% Derating at 50°C)	0°C to 40°C (32°F to 104°F) (10% Derating at 50°C)	0°C to 40°C (32°F to 104°F) (10% Derating at 50°C)
Storage Temperature °C (°F)	-20° to 60° (-4° to 140°)	-20° to 60° (-4° to 140°)	-20° to 60° (-4° to 140°)	-20° to 60° (-4° to 140°)
Relative Humidity	0% - 95%, non-condensing	0% - 95%, non-condensing	0% - 95%, non-condensing	0% - 95%, non-condensing
Operating Altitude, m (ft)	0 to 3,000 (0 to 10,000) w/o Derating (15% Derating at 4000m)	0 to 3,000 (0 to 10,000) w/o Derating (15% Derating at 4000m)	0 to 3,000 (0 to 10,000) w/o Derating (15% Derating at 4000m)	0 to 3,000 (0 to 10,000) w/o Derating (15% Derating at 4000m)
Audible Noise	< 48 dB	< 48 dB	< 48 dB	< 48 dB
Certifications				
Safety	IEC 62040-1:2008+A1 2013, IEC 62619 1st Ed., UL 1642 (Li-Ion Battery Cells), UL 1973 (Li-Ion Battery Pack w/UPS)	IEC 62040-1:2008+A1 2013, IEC 62619 1st Ed., UL 1642 (Li-Ion Battery Cells), UL 1973 (Li-Ion Battery Pack w/UPS)	IEC 62040-1:2008+A1 2013, IEC 62619 1st Ed., UL 1642 (Li-Ion Battery Cells), UL 1973 (Li-Ion Battery Pack w/UPS)	IEC 62040-1:2008+A1 2013, IEC 62619 1st Ed., UL 1642 (Li-Ion Battery Cells), UL 1973 (Li-Ion Battery Pack w/UPS)
Agency	IEC 62040-1:2008+A1 2013, IEC 62619 1st Ed., IEC 62040-2 2nd Ed., IEC 61000-3-2, IEC 61000-3-12, CISPR22, Class A	IEC 62040-1:2008+A1 2013, IEC 62619 1st Ed., IEC 62040-2 2nd Ed., IEC 61000-3-2, IEC 61000-3-12, CISPR22, Class A	IEC 62040-1:2008+A1 2013, IEC 62619 1st Ed., IEC 62040-2 2nd Ed., IEC 61000-3-2, IEC 61000-3-12, CISPR22, Class A	IEC 62040-1:2008+A1 2013, IEC 62619 1st Ed., IEC 62040-2 2nd Ed., IEC 61000-3-2, IEC 61000-3-12, CISPR22, Class A
Environmental	RoHS2 / REACH / WEEE	RoHS2 / REACH / WEEE	RoHS2 / REACH / WEEE	RoHS2 / REACH / WEEE
Network Surge	IEC 61000-4-5, ANSI C62.41, Category B	IEC 61000-4-5, ANSI C62.41, Category B	IEC 61000-4-5, ANSI C62.41, Category B	IEC 61000-4-5, ANSI C62.41, Category B
Transportation	ISTA Procedure 2A	ISTA Procedure 2A	ISTA Procedure 2A	ISTA Procedure 2A
Warranty	5 years on UPS and Battery	5 years on UPS and Battery	5 years on UPS and Battery	5 years on UPS and Battery

Optional Accessories



External battery cabinets and replacement battery kits

UPS	External battery cabinets*	Internal Replacement Battery Kits
GXT5LI-1000LVRT2UXL	VEBCLI-48VRT1U	GXT5LI-48VBATKIT1
GXT5LI-1500LVRT2UXL	VEBCLI-48VRT1U	GXT5LI-48VBATKIT2
GXT5LI-2000LVRT2UXL	VEBCLI-48VRT1U	GXT5LI-48VBATKIT2
GXT5LI-3000LVRT2UXL	VEBCLI-48VRT1U	GXT5LI-48VBATKIT2

*EBCs are hot-swappable, user-replaceable to allow for the full EBC to be replaced, as needed. Up to 8 EBCs can be used per UPS.



Network communications and environmental sensors

Network Communications	RDU101	Intellislot web card for SNMP and web management. Supports environmental sensors.
	IS-RELAY	Intellislot Interface Kit for Relay Contacts
Environmental Sensors	SN-Z01	Integrated cable with single temperature sensor
	SN-Z02	Integrated cable with three temperature sensors
	SN-Z03	Integrated cable with three temperature and one humidity sensors
	SN-T	Modular with single temperature sensor
	SN-TH	Modular with single temperature and single humidity sensor
	SN-2D	Modular with two door contact inputs
	SN-3C	Modular with three dry contact inputs
	SN-L20	Modular leak zone sensor with 20 foot cable (Liebert RDU-S only)
UPS manageability options	Vertiv™ Power Insight Software Management	Vertiv™ Power Insight is a complimentary web-based software designed to monitor up to 100 Vertiv™ UPSs and rPDUs



MicroPOD - Maintenance bypass and output distribution

The Vertiv™ Liebert® MicroPOD (Power Output Distribution) is a maintenance bypass option for UPS products, 3 kVA and below. It allows removal of the UPS without powering down the connected equipment. The 2U POD's can be installed on the floor or mounted to a Liebert® GXT5 UPS using the included mounting brackets.

UPS VA rating	POD model number	Output receptacles	Plug to utility
750-1500VA UPS	MP2-210K	(8) IEC60320-C13	IEC320-C14
2000VA UPS	MP2-220K	(8) IEC60320-C13	IEC320-C20
3000VA UPS	MP2-220L	(6) IEC60320-C13 + (1) IEC60320 C19	IEC320-C20

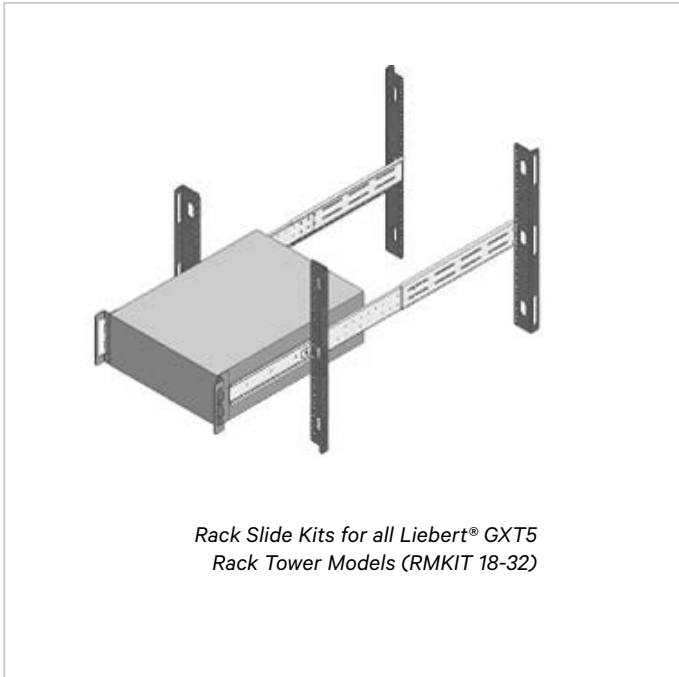

Mounting Kit Options

Application	Model Supported	Style	Model	Description
4 Post Rack	Entire GXT5 UPS family (500VA to 10kVA)	Bracket	RMKIT18-32	Cabinet/racks with 18" - 32" deep support rails - Telescopic rail

Comprehensive Services for Critical Systems

Power Package

The Power Emergency Package provides emergency support with 100% parts coverage and is available for single-phase UPS products up to 3kVA. Adding Vertiv services to your Vertiv™ GXT5 Lithium Ion UPS ensures you are protected during an emergency.

- Five years service coverage (10 with renewal)
- 24x7 professional Helpline
- Advanced replacement of the faulty unit
- Shipping costs covered by Vertiv
- Coverage for both electronic parts and battery failures
- The Power Emergency Premier version also provides remote diagnostic and preventive monitoring with Vertiv™ LIFE™ Services enabled via the optional RDU101 communication card

Installation and Start-up Services

Installation and Start-up Services provide on-site technical support for installation and start-up of your UPS or battery cabinet, ensuring you get up and running as quickly as possible.

- Installation includes mounting the new UPS and battery cabinets
- Start-up available in 2 scheduling options, 8x5 or 24x7
- Services performed by a Vertiv

Remote Diagnostic Services for Rapid Response

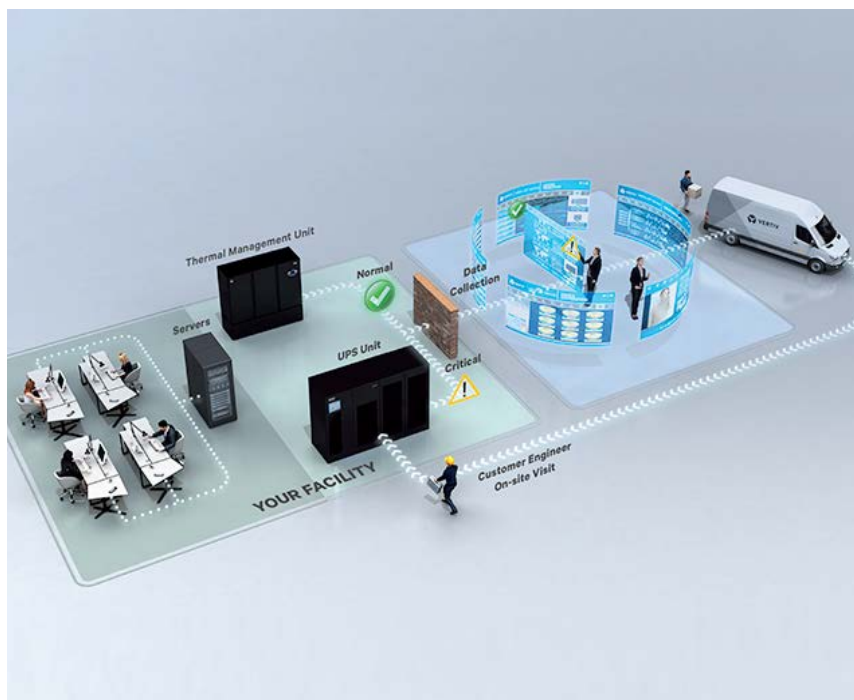

Key benefits:

- Assured critical power delivery
- Optimized use of your IT staff
- Simplified small site UPS deployment and maintenance
- Instant access to power protection information
- Improved protection for your IT investment
- Up to ten year worry-free coverage with Renewal option

Data-Driven Insight:

With Life Services you don't just have someone periodically checking equipment status. You have Vertiv experts continuously monitoring and analysing all relevant control and operating parameters from your equipment to maintain optimum performance.

Real-time Response:

Real-time data enables realtime response to potential anomalies. Rather than wait for a problem to be detected by on-site personnel, Vertiv Life Services "sees" operating issues as soon as they occur. It triggers immediate service action to prevent problems or cut hours or days off the time-to-repair, preventing or reducing downtime.

Connected Service:

Vertiv service engineers can resolve many anomalies remotely and are connected to the Vertiv field service organisation for on-site resolution. They can dispatch a field service engineer as soon as a critical condition is identified, often arming the engineer with a diagnosis so they arrive knowing the issue and with any required replacement parts.

Power Emergency Services

Service Part Number	Standard	With LIFE™ Services
RUPS-PE-004	Power Emergency 5YR-8HR RESP8X5 Group 4	GXT5 LI 1000 VA
RUPS-PE-004	Power Emergency 5YR-8HR RESP8X5 Group 4	GXT5 LI 1500 VA
RUPS-PE-005	Power Emergency 5YR-8HR RESP8X5 Group 5	GXT5 LI 2000 VA
RUPS-PE-006	Power Emergency 5YR-8HR RESP8X5 Group 6	GXT5 LI 3000 VA
RUPS-PEP-006	Power Emergency Premier 5YR-8HR RESP8X5 Group 6	GXT5 LI 3000 VA
PS-RUPS-INSTL247-006	Installation 1PH UPS 24X7 Group 6	GXT5 LI 3000 VA
PS-RUPS-ST85-006	Startup 1PH UPS 8X5 Group 6	GXT5 LI 3000 VA
PS-RUPS-ST247-006	Startup 1PH UPS 24X7 Group 6	GXT5 LI 3000 VA

Please refer to the Scope of Work for full and additional details.





Ihre EDP Ansprechpartner
RZ/IT-Infrastruktur

Mario Boer

☎ +49 (0) 62 27 8287 - 21
✉ mario.boer@edp-germany.de

Marvin Hefner

☎ +49 (0) 62 27 8287 - 19
✉ marvin.hefner@edp-germany.de

Alexander Kocergin

☎ +49 (0) 62 27 8287 - 20
✉ alexander.kocergin@edp-germany.de

Jakob Bart

☎ +49 (0) 62 27 8287 - 14
✉ jakob.bart@edp-germany.de

Nicolas Lotz

☎ +49 (0) 62 27 8287 - 15
✉ nicolas.lotz@edp-germany.de

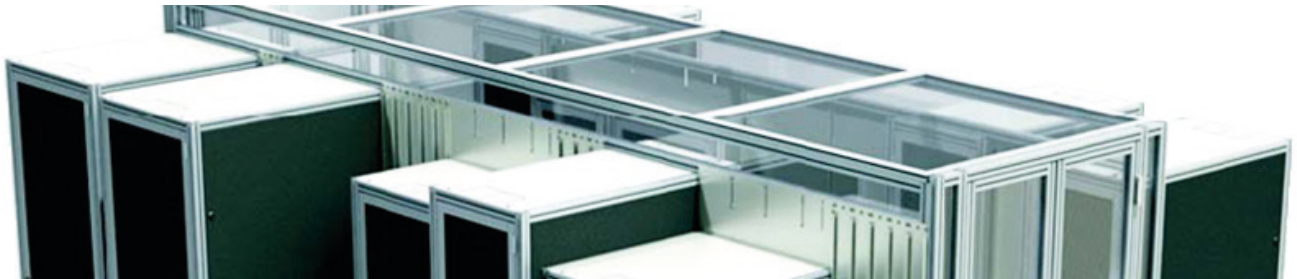

Kompetenz rund um Rechenzentrum und IT-Raum

19" Racks



offen, geschlossen,
schallgedämmt, klimatisiert

IT-Safes + Schutzschränke



19" Brandschutzschränke
& RZ Container-Lösungen

Airflow-Management

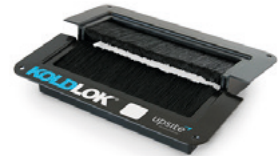

Lösungen für
Doppelboden, Rack und Raum

IT-Infrastruktur Innovative und individuelle Lösungen



Monitoring, Infrastruktur-Management / DCIM, Patchkabel Kupfer und LWL,
Stromverteilung / PDU's, ... bis hin zu RZ-Containern und IT-Einhausungen,
Datenträgervernichtung, Labelservice, Datenträgerrettung, Datenträgerlagerung,
Tape-Services, USV-Service und RZ Reinigung

Klima-Kühlösungen

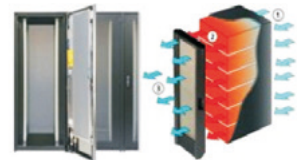

verschiedene Technologien
für Raum und/oder 19"-Rack

Unterbrechungsfreie Stromversorgung - USV



1 phasig / 3 phasig, Zubehör,
Wartung, Service, Ersatz-Batterien

Starke Partnerschaften





Kompetenz rund um Barcode-Label und Magnetbänder

Magnetbänder



aller Hersteller und Technologien,
mit und ohne Barcode-Label

Magnetbandarchivierung



Transportkoffer, Regale,
Schränke und Safes

Magnetbandvernichtung



direkt vor Ort,
zertifizierte Vernichtung

Zertifizierte Barcode-Label für alle Libraries vom Marktführer EDP

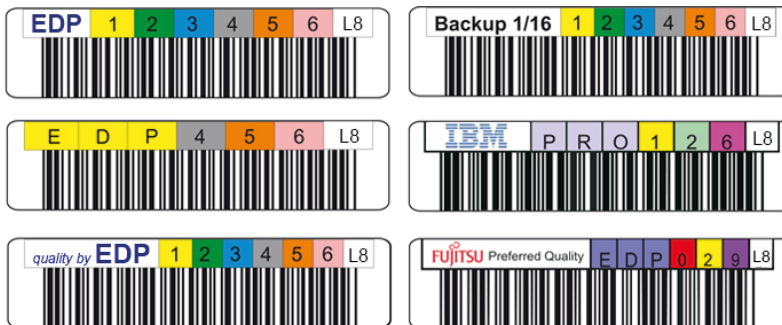

EDP Barcode-Label sind von allen Library-Herstellern zertifiziert
und werden mit einem individuellen Nummernkreis für
Standard-Label, Custom-Label, Orga-Label und RFID-Label geliefert

Magnetbandrettung - Magnetband-Management



bei beschädigten Datenträgern

DC-Analyser



aussagekräftige Analyse
von LTO-Datenträgern

Starke Partnerschaften

